

TC5081BP

PHASE COMPARATOR

The TC5081BP is phase comparator for PLL frequency synthesizer type, and consists of a digital phase comparator and an amplifier for active low pass filter.

FEATURES

- The phase comparator detects two input pulse phase differences and outputs proportionate positive or negative pulses to PD_{OUT}. When the input pulse phases are the same, PD_{OUT} has high impedance.
- Because the IC is CMOS, the input impedance of the filter for the amp is extremely high and has excellent characteristics.
- TC5081BP comes in a SIP 9 PIN.

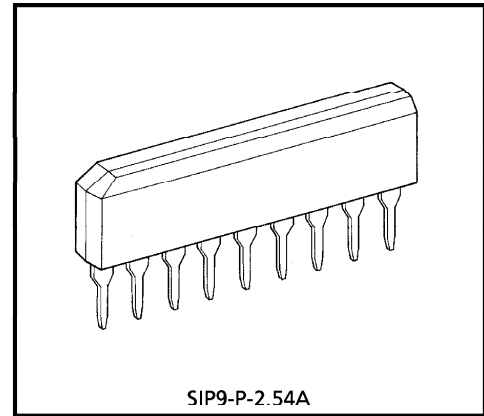

Weight : 0.92g (Typ.)

LOGIC DIAGRAM

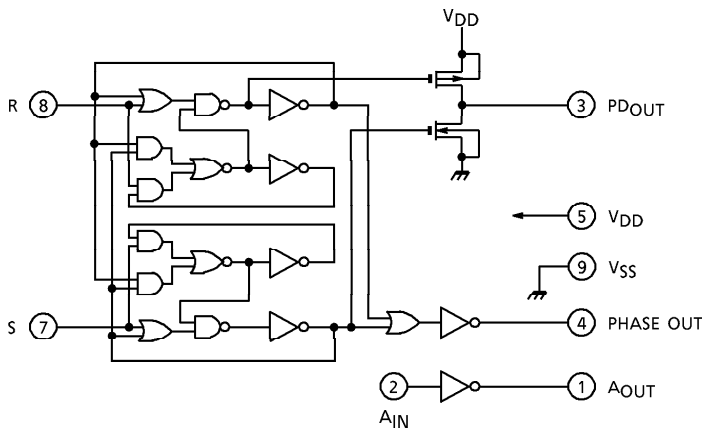

PIN CONNECTION (SIDE VIEW)

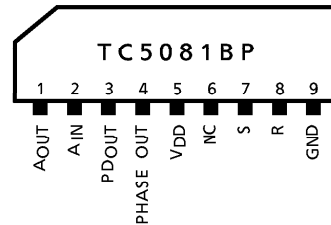

PHASE COMPARATOR TIMING CHART

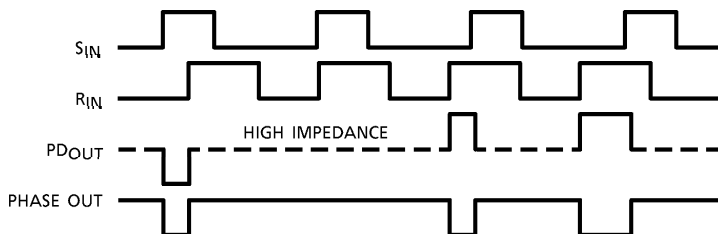

961001EBA2

● TOSHIBA is continually working to improve the quality and the reliability of its products. Nevertheless, semiconductor devices in general can malfunction or fail due to their inherent electrical sensitivity and vulnerability to physical stress. It is the responsibility of the buyer, when utilizing TOSHIBA products, to observe standards of safety, and to avoid situations in which a malfunction or failure of a TOSHIBA product could cause loss of human life, bodily injury or damage to property. In developing your designs, please ensure that TOSHIBA products are used within specified operating ranges as set forth in the most recent products specifications. Also, please keep in mind the precautions and conditions set forth in the TOSHIBA Semiconductor Reliability Handbook.

MAXIMUM RATINGS (Ta = 25°C)

CHARACTERISTIC	SYMBOL	RATING	UNIT
Supply Voltage	V _{DD}	15	V
Input Voltage	V _{IN}	-0.3~V _{DD} +0.3	V
Operating Temperature	T _{opr}	-30~75	°C
Storage Temperature	T _{stg}	-55~125	°C

ELECTRICAL CHARACTERISTICS (V_{DD} = 7.5V, Ta = -30~75°C)

CHARACTERISTIC	SYMBOL	TEST CIRCUIT	TEST CONDITION	MIN.	TYP.	MAX.	UNIT
Operating Supply Voltage	V _{DD}	—	—	4.5	—	12	V
Output Voltage	"H" Level	V _{OH}	V _{IH} = 6.6V, V _{IL} = 1.6V	7.3	—	—	V
	"L" Level	V _{OL}					
Quiescent Current	I _{DD}	—	V _{IH} = 7.5V, V _{IL} = 0V	—	—	200	μA
3 State Leak Current	"H" Level	I _{TLH}	—	—	—	500	nA
	"L" Level	I _{TLL}					
Filter Amp. Voltage Gain	G _V	3	R _{①-②} = 1MΩ, f _{IN} = 1kHz R _g = 600Ω	—	30	—	dB

TEST CIRCUIT 1

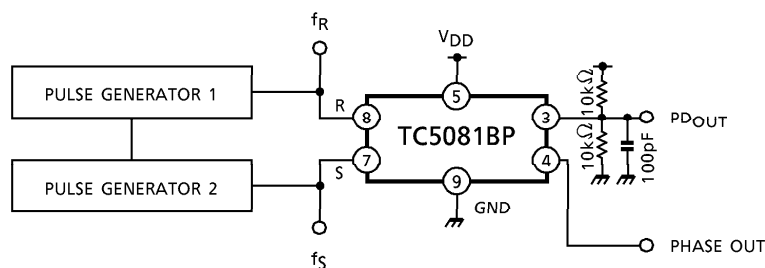

The pulse generator-1 is synchronized with the pulse generator-2.
Then, the phase of f_R and f_S is variable.

961001EBA2'

- The products described in this document are subject to foreign exchange and foreign trade control laws.
- The information contained herein is presented only as a guide for the applications of our products. No responsibility is assumed by TOSHIBA CORPORATION for any infringements of intellectual property or other rights of the third parties which may result from its use. No license is granted by implication or otherwise under any intellectual property or other rights of TOSHIBA CORPORATION or others.
- The information contained herein is subject to change without notice.

WAVE FORM 1 (The leading phase, $f_S > f_R$)

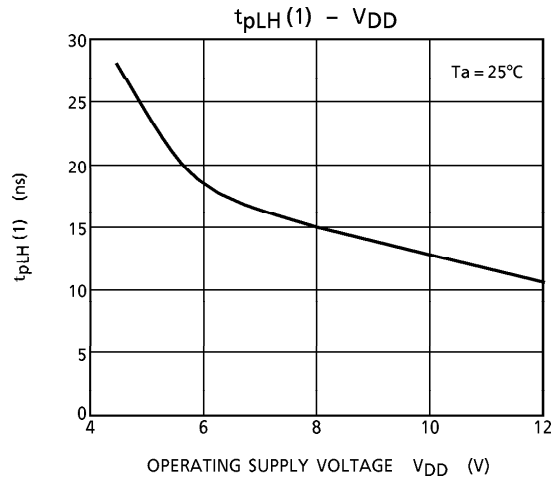
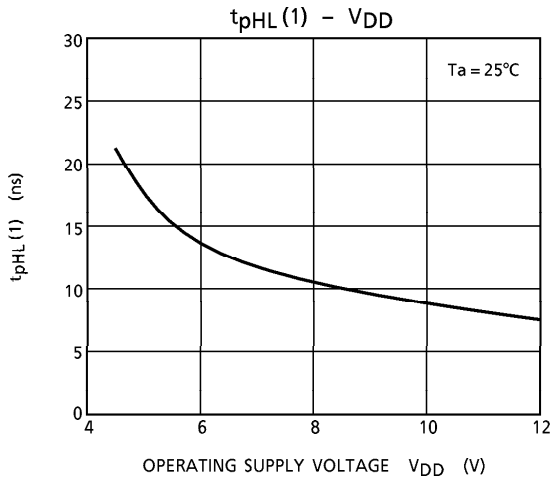
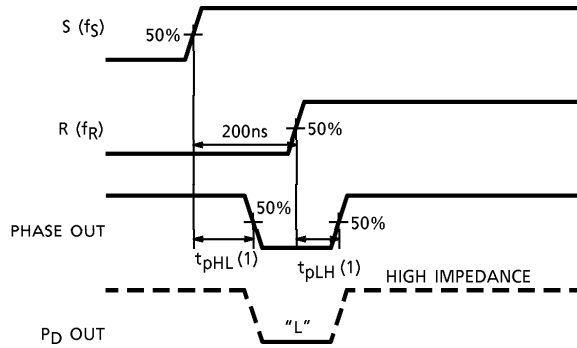

WAVE FORM 2 (The lagging phase, $f_S < f_R$)

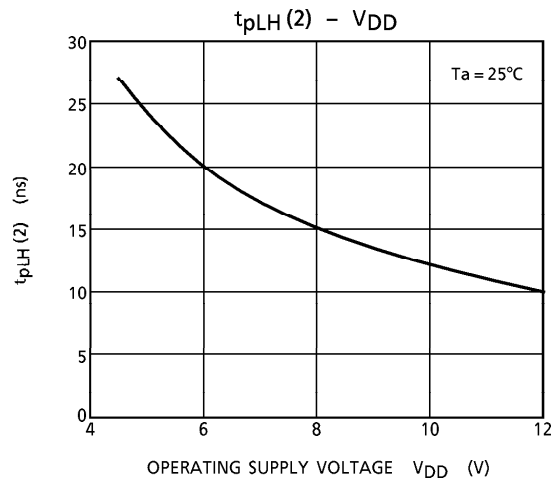
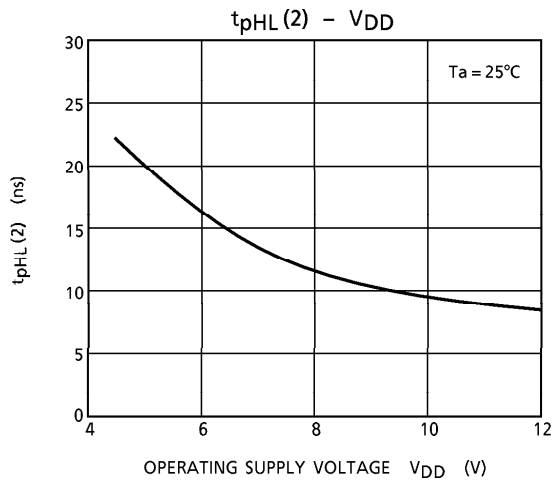
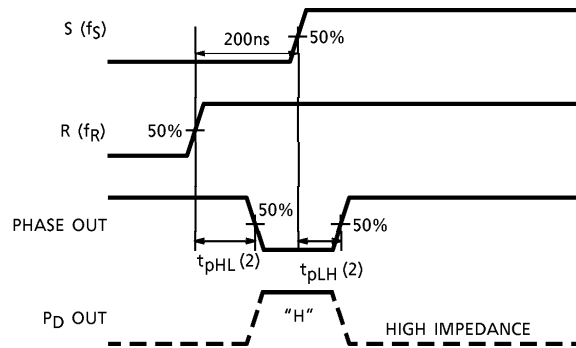

TEST CIRCUIT 2

V_{DD}-I_{DD}

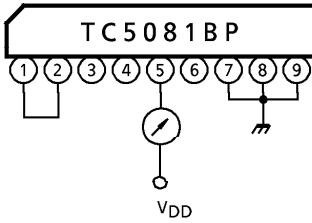

TEST CIRCUIT 3

G_V-V_{DD}

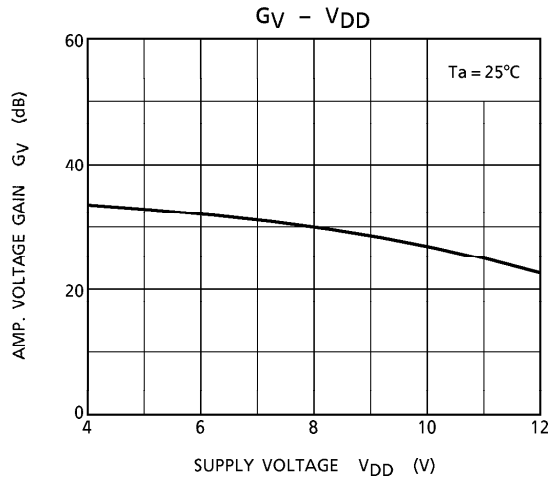
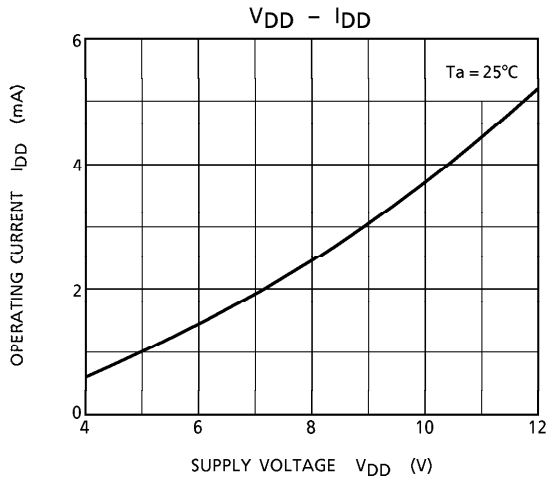
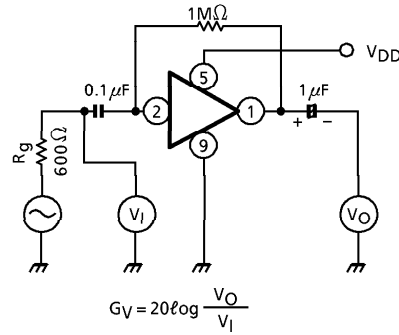

OUTLINE DRAWING
SIP9-P-2.54A

Unit : mm

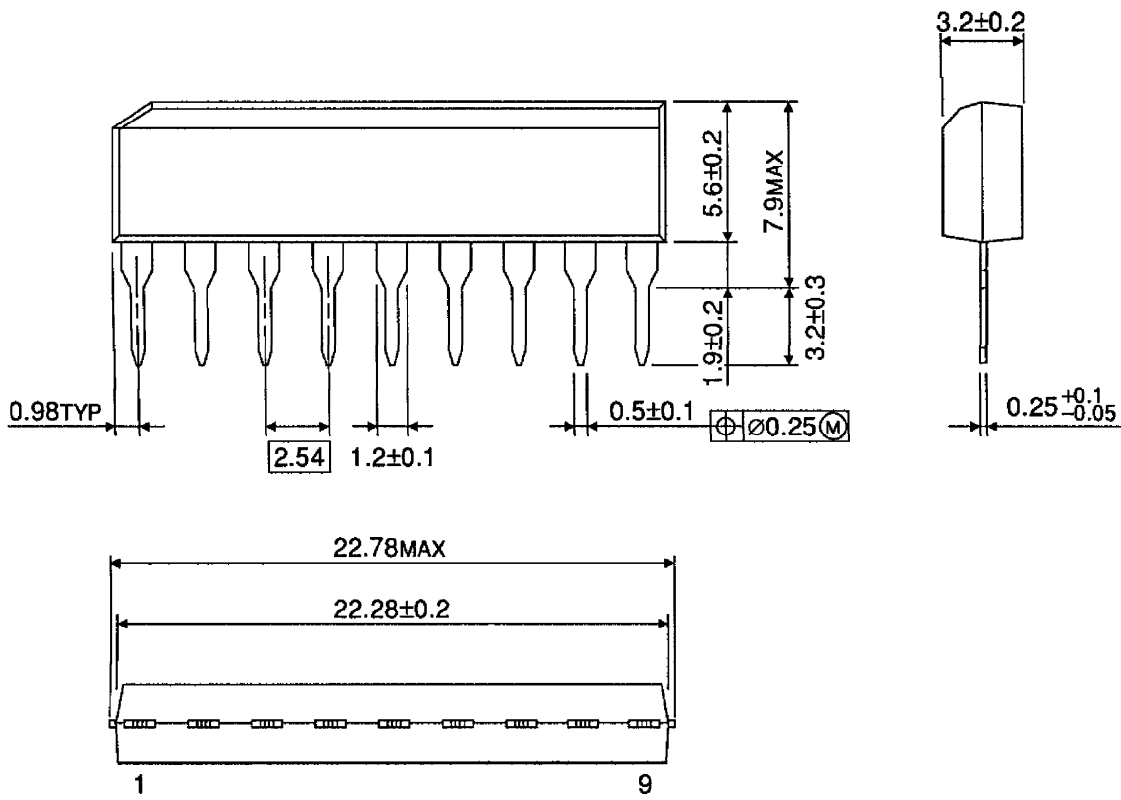

Weight : 0.92g (Typ.)